



WINDOW, DOOR, & GLAZING SUPPLIES

CATALOGUE

**Window and Door Components
4504 10 Street NE
Calgary AB T2E 6K3
Phone: 403 938 1064
orders@wndc.ca**



WINDOW COMPONENTS



Window and Door Components
4504 10 Street NE
Calgary AB T2E 6K3
www.wndc.com

WINDOW COMPONENTS

WINDOW ROLLERS

WR-4231-1000 (Composite Rollers)

WR-4231-1000B (Brass Rollers)

WR-4257-1000 (Composite Roller)

NOT SHOWN

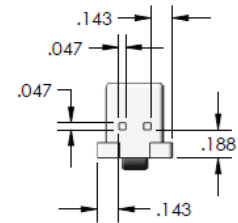
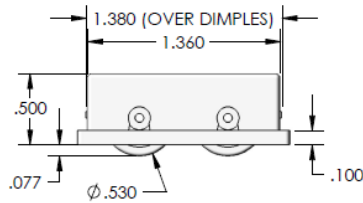
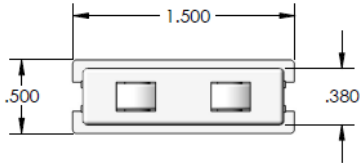
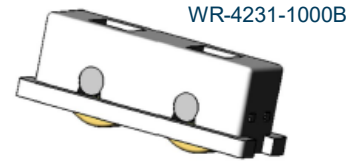
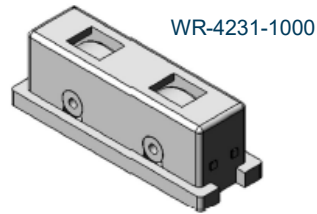

W

HOLE PLUGS

SHC89

3/8" Nylon Hole Plug

White

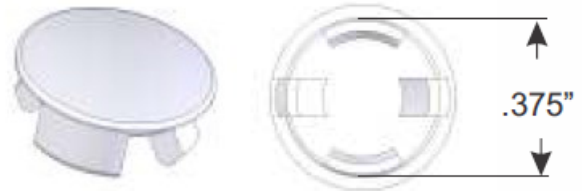

WEEP HOLE COVERS

SWHC109WH

SWHC525

Available Colors: Black, White

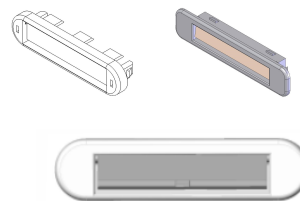

Window and Door Components
4504 10 Street NE
Calgary AB T2E 6K3
www.wndc.com

LOCKS & KEEPERS

COMPOSITE SWEEP LOCKS

<u>Lock</u>	<u>Hole Centers</u>	<u>Thickness</u>	<u>Projection</u>
2922	2.250"	.165"	.500"
2925	2.250"	.145"	.500"
2927	2.250"	.145"	.375"

Available Colors: White, Clay, Tan



COMPOSITE SASH LOCKS

2203

- 2.060" Hole Space
- 0.687" Backset

Works with any of the keepers below

Available Colors: White, Clay



COMPOSITE KEEPERS

2200-202 (Top Mount)

2200-214 (Top Mount)

Interlocking Nibs— works with Veka

Profiles **200-401** (Face Mount)

Available Colors: White, Clay



Window and Door Components
4504 10 Street NE
Calgary AB T2E 6K3
www.wndc.com

WINDOW COMPONENTS



Hinges

Casement Hinges

Introducing our high-performance casement hinge, meticulously engineered to meet the exacting demands of modern window manufacturing. As energy specifications and the trend towards larger windows continue to evolve, traditional hinges struggle to keep pace. That's where our solution comes in, boasting impressive weight-carrying capabilities to accommodate triple pane or laminated glass. Our hinge features a deeper interlocking track, ensuring superior performance on impact and load testing, while an integrated snubber adds extra security and strength in blowout scenarios. With additional fixing holes to prevent bending and enhance sash stability, plus adjustable eccentric track rivets for easy on-the-field adjustments, our hinge offers unparalleled versatility and reliability. Crafted from heavy-duty stainless steel, available in standard grade stainless steel or optional austenitic stainless steel, and featuring a fast and secure snap-on attachment, it's the ultimate choice for manufacturers seeking durability and performance. Available in both 10 and 13-inch versions, with the same hole configurations as industry standards, our hinge seamlessly integrates into any window design, ensuring optimal functionality for years to come. Egress and standard wash-ability hinges available.



Drawings and technical info available upon request.

Awning Hinges

Welcome to our advanced Awning Hinge, engineered for unparalleled window performance. Crafted with precision, this hinge ensures smooth, effortless operation as it expertly balances your sash during opening. Its stainless steel reinforced shoe guarantees continuous smooth action, while detachable support arms facilitate quick sash installation into the frame. Each hinge size is meticulously designed to perfectly balance specific sash sizes and weights. Customize your windows movement with the adjustable friction screw, preventing sash rattling. Featuring adjustable eccentric track rivets for easy field adjustments and a clip-on feature for secure sash-to-frame attachment, our hinge prioritizes both convenience and security. Integrated snubbers provide extra strength during impact testing, with additional fixing holes to enhance stability for heavy sashes. Available in sizes ranging from 10 to 26 inches, and offered in standard grade stainless steel or optional austenitic stainless steel our hinge meets industry standards with its heavy-duty stainless steel track. Experience superior window functionality with our Awning hinge, designed to elevate your space with unmatched reliability and performance.



Drawings and technical info available upon request.



Window and Door Components
4504 10 Street NE
Calgary AB T2E 6K3
www.wndc.com

WINDOW COMPONENTS



Locks

Standard LTS

The LTS lock boasts a sleek and contemporary design, characterized by its clean lines, making it a discreet yet stylish addition to any window. Available in a wide array of colors and finishes, it effortlessly complements various window types prevalent in the industry. Equipped with a pre-installed seal for added protection, it features a robust mechanism ensuring durability and security. With a generous 1.20" stroke, it provides ample locking capability. Crafted with PVC cutting to meet industry standards, it seamlessly integrates with all our multi-point systems, ensuring compatibility and ease of installation.

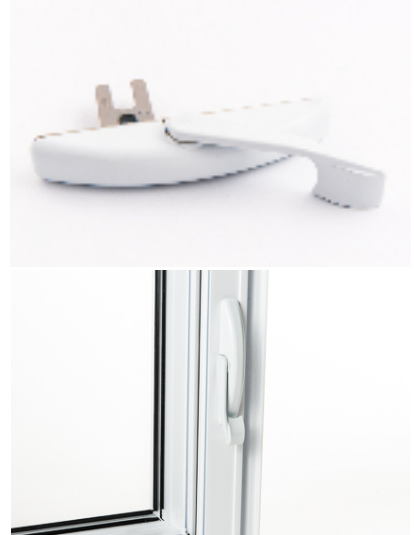

Contemporary

The Contemporary lock embodies innovation and elegance with its sleek, new contemporary design. Crafted as a refined successor, its lever mechanism boasts unparalleled smoothness and ease of use, elevating the user experience to new heights. Not only does it sport a modern aesthetic that effortlessly aligns with current trends, but its low profile, 45% thinner than previous models, ensures a seamless integration into any space. Furthermore, its design allows full clearance for blinds, catering to practical needs without compromising style. With increased leverage and Canadian design ingenuity, the Contemporary lock sets a new standard in both form and function.

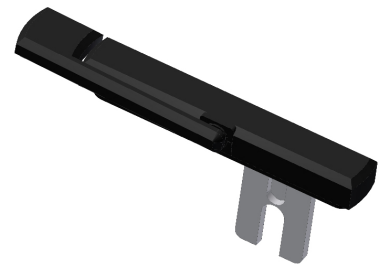

4504 10 Street NE
Calgary AB T2E 6K3
www.wndc.com

WINDOW COMPONENTS



Operators

Introducing the EVOLUTION operator platform for casement windows, a revolutionary advancement in window technology. Crafted by our skilled engineers, this innovative and patented design guarantees unparalleled performance and reliability. Its optimized gear mechanism ensures seamless operation, offering unmatched smoothness and ease of use. With improved assembly precision and an optimized gear ratio, the EVOLUTION platform minimizes the "tossing" effect of the shutters, providing a stable and secure experience. For added aesthetic appeal, customers have the option to choose a contemporary cover and crank. Proudly boasting a patented Canadian design, the EVOLUTION platform sets a new standard in window functionality and style



Casement

- Dual Arm Operator
- Short Dual Arm Operator
- Egress Short Dual Arm Operator
- Single Arm Dyad Operator
- Reverse Dyad Operator

Awning

- Scissor Awning Operator
- Short Awning Operator



4504 10 Street NE
Calgary AB T2E 6K3
www.wndc.com

WINDOW COMPONENTS



Tie Bars

The **Trifecta Series** offers a versatile solution for various applications with standard lengths ranging from 16" to 72". With pre-installed guides, installation is not only direct but also efficient, saving both time and costs. Its full cam adjustability enables convenient adjustments both on-site and off-site, ensuring optimal locking operation. Designed for durability, it comes in standard 430 stainless steel or optional 304 austenitic stainless steel, ideal for coastal environments. Transitioning to the Trifecta Series is seamless as it is available in configurations similar to other commonly used systems. Moreover, its customizable feature allows for up to 5 locking points, catering to specific needs and preferences



Introducing the **ILA Series**, featuring the innovative Adjustable Interlock Roller system, offering standard lengths ranging from 11" to 79". Engineered for convenience and efficiency, pre-punched positioned holes and guides streamline installation, translating to significant cost and time savings. With full cam adjustability, adjustments can be made both on-site and off-site while ensuring optimal locking operation. The ILA Series boasts a comprehensive range of security keepers paired with customizable heavy-duty guides, meeting the highest impact test ratings. For varied environmental demands, it's available in a standard powder-coated finish or optional 304 austenitic stainless steel, ideal for coastal applications. Compatibility is seamless, as it's designed in configurations akin to commonly used systems, facilitating effortless transitions. Customization is key, with the ability to tailor up to 5 locking points to suit specific requirements.



The **Cone Roller Series** offers Cone Roller technology, featuring rollers with a conic shape designed to extend keeper reach and ensure strong, progressive compression of the sash. With standard lengths ranging from 11" to 79", these rollers are adaptable to various window sizes. Alongside their innovative design, the CR Series provides a complete range of security keepers and customizable heavy-duty guides, enabling compliance with the highest impact test ratings. Additionally, they are available in powder-coated finish or optional 304 austenitic stainless steel, ideal for coastal applications. The system maintains versatility by offering configurations similar to other commonly used systems, facilitating a seamless transition. Moreover, it's customizable, accommodating up to 5 locking points to suit specific security needs.



4504 10 Street NE
Calgary AB T2E 6K3
www.wndc.com

WINDOW COMPONENTS



Accessories

Snubbers

Snubbers offer versatile solutions for window security, adaptable to any window type with several options available. Not only do they prevent tall sashes from bowing, ensuring the structural integrity of windows, but they also bolster home security by providing enhanced protection against intrusion. Moreover, they significantly boost impact test performance ratings, assuring homeowners of their effectiveness in safeguarding their property



Fixed Ramp

The addition of a fixed ramp to multipoint tie bar systems extends their reach range by an extra half inch, or 0.500 inches, facilitating smoother locking movements on higher sashes. This straightforward enhancement not only improves functionality but also minimizes the likelihood of after-sales service calls, demonstrating its practical value in enhancing both user experience and long-term product satisfaction.



Tie Bar Guides

With our extensive array of Tie Bar Guides, we've got your window requirements covered comprehensively. Whether it's for residential, commercial, or industrial purposes, you can trust us to deliver precisely what you need. Our commitment to meeting your specifications is unwavering, ensuring that each Tie Bar Guide is tailored specifically to the window system you're manufacturing.

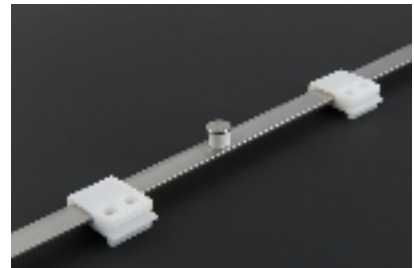

Keepers

Our comprehensive selection of casement and awning keepers ensures that all your window requirements are met with precision. Whether you need a durable metal keeper or a high-performance composite hybrid, we have the perfect solution tailored to your specifications. Trust in us to provide keepers designed for each specific window application, guaranteeing both reliability and efficiency in every installation.



4504 10 Street NE
Calgary AB T2E 6K3
www.wndc.com

WINDOW COMPONENTS



BALANCES

Sideload Constant Force Balance System

John Evans' Sons is a leader in Constant Force Balance Systems. Their unique Side Load System is a leading product for the industry. Our SideLoad Constant Force Balance System uses AAMA-qualified springs and is a simple conversion from block & tackle.

Compared to block & tackle, the SideLoad Balance System offers:

- A lower price
- Significantly reduced operating forces
- A substantial reduction of on-hand inventory
- Dramatically smaller space requirements
- A tighter-fitting sash



fig. 1



fig. 2

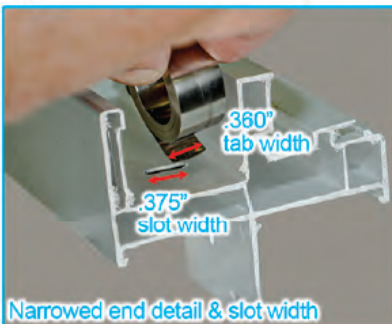

fig. 3

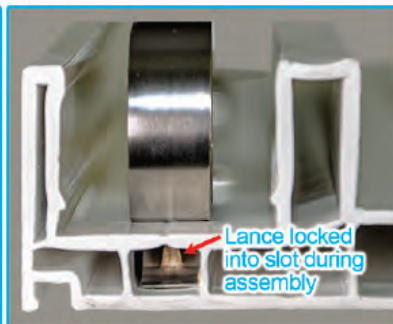

fig. 4

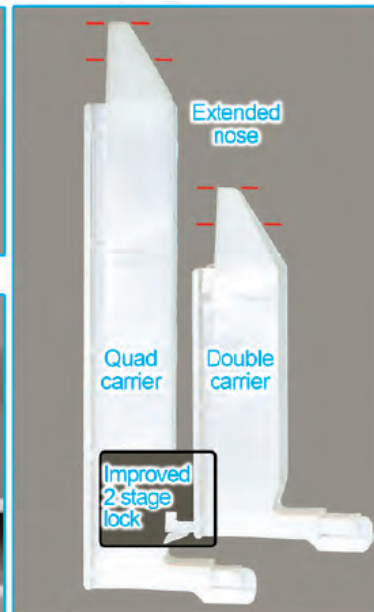

fig. 5



WINDOW COMPONENTS

JOHN

EVANS'
SONS Est. 1850

BALANCES

Di FLEX BALANCE SERIES

The most flexible constant force balance system for 1/2" sash windows. Available in Fixed Configuration or Inverted Configuration

Offers the following:

Ability to transition from a fixed coil balance to an inverted coil balance by simply changing the mounting orientation and attaching a mounting clip to the coil spring.

Reduced SKU s, springs are pre-assembled in holders (singles and doubles), quickly make triple and quad assemblies by connecting the spring assemblies together



Fixed Configuration

Inverted Configuration



Window and Door Components
4504 10 Street NE
Calgary AB T2E 6K3
www.wndc.com



Seals

Gaskets

Tapes

BULB SEAL



Upright VT-Series

- Upright T-Slot Compression Seals Designed For 25% Compression Of Overall Height For Optimal Performance.
- Closed Cell Foam Construction To Minimize Water Absorption.
- Certified To AAMA 702-11 Class A Extra-High Performance.

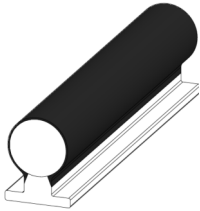

CVT2500-BLK	0.250" reach - Black #110
CVT2501-BLK	0.250" reach Black #110 (.1850)
CVT2502-BLK	0.300" reach - Black #110 (270)
CVT3000-BLK	0.300" reach -Black #110
CVT3500-BLK	0.350" reach - Black #110
CVT3750-BLK	0.375" reach -Black #110



Offset T-Slot with Flap

- Offset T-Slot Compression Seals Designed For 25% Compression Of Overall Height For Optimal Performance.
- Closed Cell Foam Construction To Minimize Water Absorption.
- Certified To AAMA 702-11 Class A Extra-High Performance.

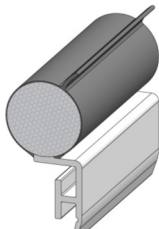

HT3001-BLK	0.300" reach - Black #110
HT3501-BLK	0.350" reach -Black #110
WR-HT4001-BLK	0.400" reach -Black #110
HT4501-BLK	0.450" reach Black #110



Window and Door Components
4504 10 Street NE
Calgary AB T2E 6K3
www.wndc.com

PROTECTIVE FILM, FOAM, & PADS

ADHESIVE SHIPPING/BUNK PADS & STATIC CORK PADS

XLPE single sided adhesive shipping pads that can be applied directly to finished aluminum & vinyl surfaces. No residue left behind. Permanent adhesive & various densities available.

Static cling cork pads for glass protection.

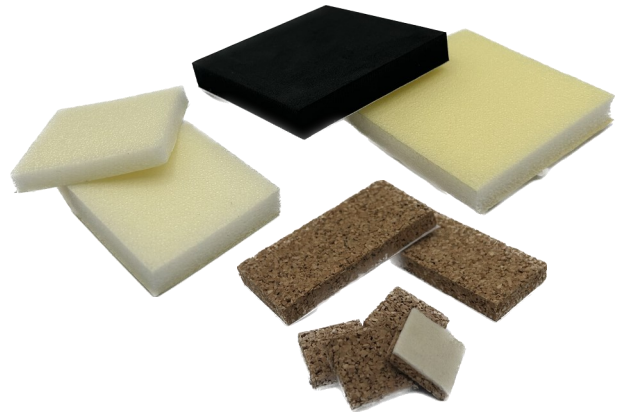

WINDOW & GLASS PROTECTION FILM

Protects windows for up to 60 days with clean removal, leaving no residue behind.

Uses: Construction, Renovations, Interior & exterior painting, Door & window manufacturing, Plastering, Stucco, Brick acid washing

WR-WF24-600C 24" x 600 feet / roll

WR-WF36-600C 36" x 600 feet / roll

WR-WF48-600C 48" x 600 feet / roll



WINDOW PROTECTION FOAM

Polyethylene fused U Channel Foam. Ensures a safe, cushioned ride for your product.

WSP-F200-1800 - U Channel Foam (Blue) 0.80"x 1.50"

Available in Gaylord Box - 1,800 feet per box



ALUMINUM & VINYL PROTECTION FILM

Adhesive films that can be applied to vinyl & anodized or painted aluminum extrusions.

UV resistant option available for finished products that will be exposed to sunlight for up to 6 months.



Window and Door Components
4504 10 Street NE
Calgary AB T2E 6K3
www.wndc.com

GLAZING TAPE & SETTING BLOCKS

GLAZING TAPE

A.A.M.A approved glazing tape made of closed cell foam. Creates the seal between the insulated glass panel and window sash or door material, preventing air and water leakage. Effective in vinyl, wood and aluminum windows.



WR-GT1612 – Glazing Tape 1/16" x 1/2"

WR-GT1638 – Glazing Tape 1/16" x 3/8"

WR-GT1812 – Glazing Tape 1/8" x 1/2"

WR-GT1838 – Glazing Tape 1/8" x 3/8"

WR-GT3212 – Glazing Tape 3/32" x 1/2"

WR-GT3238 – Glazing Tape 3/32" x 3/8"

SETTING BLOCKS

TPE with adhesive backs. Protects the insulated glass unit (IG) from the impact of opening/closing the sash. Provides stress relief as vinyl windows expand and contract with changes in temperature and humidity. Keeps glass from cracking and protects the integrity of the glazing bead.



WR-SB185834 Setting Blocks 1/8"x 5/8"x 3/4"

WR-SB183434 Setting Blocks 1/8"x3/4"x3/4"

WR-SB1811 Setting Blocks 1/8"x1"x1"

WR-SB365834 Setting Blocks 3/16"x 5/8"x 3/4"

WR-SB363434 Setting Blocks 3/16"x3/4"x3/4"

WR-SB3611 Setting Blocks 3/16"x1"x1"

WR-SB165834 Setting Blocks 1/16"x 5/8"x 3/4"

WR-SB163434 Setting Blocks 1/16"x3/4"x3/4"

WR-SB1611 Setting Blocks 1/16"x1"x1"

SDL TAPE

Solvent-free alternative for adhering wood, painted aluminum and PVC-extruded muntin bars to simulated divided light (SDL) windows and doors. Engineered for long-term performance of interior and exterior simulated divided light (SDL) bars.

- Consistent thickness
- Withstands exposure to moisture and common household cleaners
- UV-resistant adhesive compensates for thermal expansion and contraction

WR-AR8626-078 – SDL Tape (Grey) 1/32" x 7/8" x 216 feet per roll

WR-AR8626-100 – SDL Tape (Grey) 1/32" x 1" x 216 feet per roll

WR-AR8626-114 – SDL Tape (Grey) 1/32" x 1 1/4" x 216 feet per roll

WR-AR8626-118 – SDL Tape (Grey) 1/32" x 1 1/8" x 216 feet per roll

WR-AR8626-138 – SDL Tape (Grey) 1/32" x 1 3/8" x 216 feet per roll



**CONTACT US FOR INFORMATION AND PRICING ON ALL ITEMS.
ADDITIONAL STYLES/COLORS AVAILABLE UPON REQUEST.**



Window and Door Components
4504 10 Street NE
Calgary AB T2E 6K3
www.wndc.com



SCREEN COMPONENTS

G7 F99 B'7 CA DCB9 BHG'

"6 Uf'UbX'7 cfbYf'

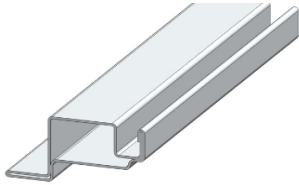

3/8 Offset Lip Screen Bar

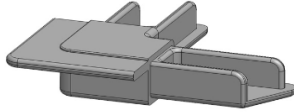

3/8 Reverse Lip Bar Corner

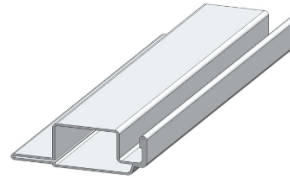

3/8 Reverse Lip Screen Bar

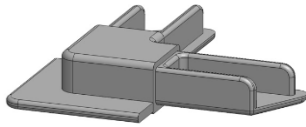

3/8 Lip Bar Corner

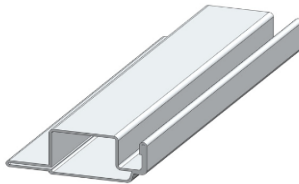

3/8 Lip Screen Bar

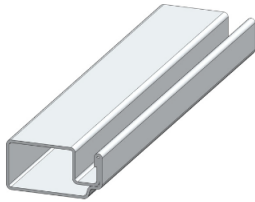

3/8 x 3/4 Screen Bar

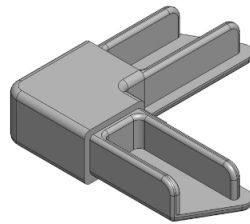

3/8 x 3/4 Screen Corner

Ultra Screen Bar

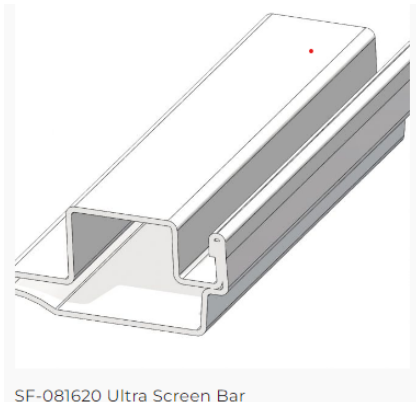

SF-081620 Ultra Screen Bar

Elite Screen Bar

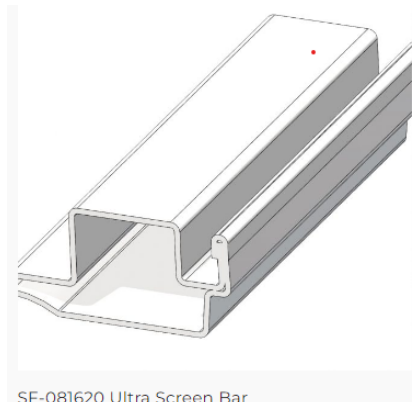

SF-081620 Ultra Screen Bar



Window and Door Components
4504 10 Street NE
Calgary AB T2E 6K3
www.wndc.com

SCREEN COMPONENTS

5/16" Bar and Corner

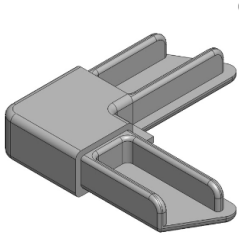

5/16 x 3/4 Screen Corner

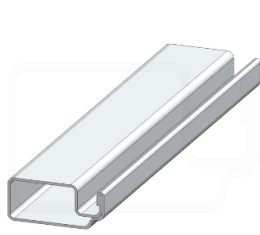

5/16 x 3/4 Screen Bar

7/16" Bar and Corner

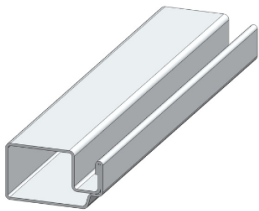

7/16 x 3/4 Screen Bar

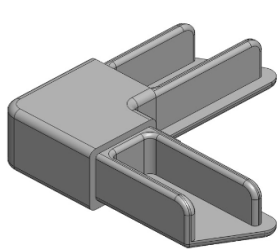

7/16 x 3/4 Screen Corner



Window and Door Components
4504 10 Street NE
Calgary AB T2E 6K3
www.wndc.com

SCREEN COMPONENTS

SCREEN FABRIC

Woven fiberglass screen that is protected with a vinyl coating. Noncombustible and will not rust, stain, or corrode

SM-FG18FL-BL-600	18" x 600' Fiberlink Fiberglass Screen Mesh BLACK [21]
SM-FG20-BL-100	20" x 100' Fiberglass Screen Mesh BLACK
SM-FG20FL-BL-600	20" x 600' Fiberlink Fiberglass Screen Mesh BLACK [22]
SM-FG22-BL-100	22" x 100' Fiberglass Screen Mesh BLACK
SM-FG24 -BL-100	24" x 100' Fiberglass Screen Mesh BLACK [6]
SM-FG24FL-BL-600	24" x 600' Fiberlink Fiberglass Screen Mesh BLACK [28]
SM-FG26FL-BL-600	26" x 600' Fiberlink Fiberglass Screen Mesh BLACK [31]
SM-FG30 -BL-100	30" x 100' Fiberglass Screen Mesh BLACK
SM-FG30FL-BL-600	30" x 600' Fiberlink Fiberglass Screen Mesh BLACK [36]
SM-FG36 -BL-100	36" x 100' Fiberglass Screen Mesh BLACK
SM-FG36FL-BL-600	36" x 600' Fiberlink Fiberglass Screen Mesh BLACK [44]
SM-FG48 -BL-100	48" x 100' Fiberglass Screen Mesh BLACK
SM-FG48FL-BL-600	48" x 600' Fiberlink Fiberglass Screen Mesh BLACK [57]
SM-FG60 -BL-100	60" x 100' Fiberglass Screen Mesh BLACK
SM-FG72-BL-100	72" x 100' Fiberglass Screen Mesh BLACK

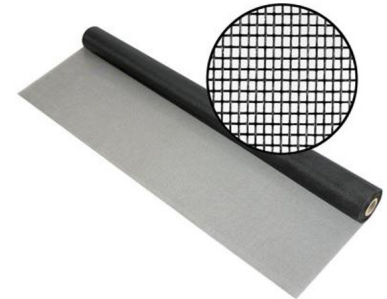

SPLINE

PS-0120PF-BL-5400	.120 Polyfoam Spline 5,400 ft
PS-0140PF-BL-4490	.140 Polyfoam Spline 4,490 ft [10/r]
PS-0150PER-BL-3000	.150 POLY Ribbed Spline 3,000 ft [15/r]
PS-0150PF-BL-3540	.150 Polyfoam Spline 3,540 ft [9/r]
PS-0153PO-BL-3000	.153 Poly Spline 3000 ft/r [18]
PS-0153PO-BL-4000	.153 Poly Spline 4000 ft/r
PS-0155PER-BL-3000	.155 POLY Ribbed Spline 3,000 ft [15/r]
PS-0155PO-BL-4000	.155 Poly Spline 4000 ft/r
PS-0160H-BL-3000	.160 Rigid Foam Spline 3,000 ft/roll
PS-0160PF-BL-2850	.160 Polyfoam Spline 2,850 ft [7/r]
PS-0165PER-BL-3000	.165 POLY Ribbed Spline 3,000 ft [17/r]
PS-0170H-BL-2700	.170 Rigid Foam Spline 2,700 ft/roll
PS-0170PF-BL-2700	.170 Polyfoam Spline 2,700 ft [8/r]
PS-0175PER-BL-2700	.175 POLY Ribbed Spline 2,700 ft [17/r]
PS-0180H-BL-2550	.180 Rigid Foam Spline 2,550 ft/roll
PS-0180PF-BL-2240	.180 Polyfoam Spline 2,240 ft [7/r]
PS-0190PF-BL-2000	.190 Polyfoam Spline 2,000 ft
PS-0210H-BL-1500	.210 Rigid Foam Spline 1,500 ft/roll
PS-0225PF-BL-1490	.225 Polyfoam Spline 1,490 ft



.140 Foam Spline Hard



.140 Polyfoam Spline



Window and Door Components
4504 10 Street NE
Calgary AB T2E 6K3
www.wndc.com

SCREEN COMPONENTS

BUG FLAP

Black vinyl bug flap. Adjusts width from 7/8" to 1-3/8". Pushes into the screen frame to prevent insects from passing under the screen.



WR-BF Bug Flap #1 400'/roll

SCREEN DOOR ROLLERS

Wire spring tension roller with 1-1/4" or 1" wheel for sliding screen doors. May be used as a top or bottom roller.

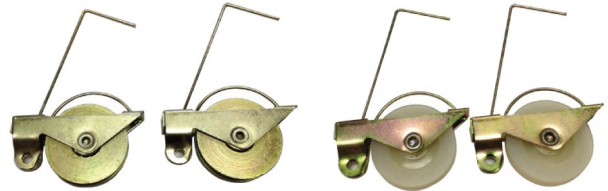

WR-1123SRC-NH Steel Carriage and 1 1/4" Nylon Roller W/Hook

WR-1123SRC Steel Carriage and 1 1/4" Steel Roller

LEAF SPRINGS



PULL TABS

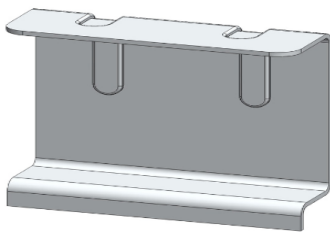

Screen Pull Aluminum 1"



Screen Pull Nylon 1"

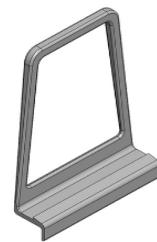

Screen Pull Plastic 1"

**CONTACT US FOR INFORMATION AND PRICING ON ALL ITEMS.
ADDITIONAL STYLES/COLORS AVAILABLE UPON REQUEST.**



Window and Door Components
4504 10 Street NE
Calgary AB T2E 6K3
www.wndc.com



DOOR COMPONENTS



Window and Door Components
4504 10 Street NE
Calgary AB T2E 6K3
www.wndc.com

DOOR COMPONENTS

DOOR WEATHERSTRIP

MATERIAL

Film — Polyethylene (PE)

Foam — Polyurethane (PU)

Insert (hard) — Polypropylene (PP)

Insert (soft) — Thermoplastic Elastomer (TPE)

QEBD650 Weatherstrip

(Exposed Barb Kerf In Weatherstrip with .650" Reach)

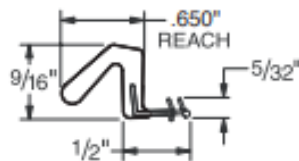

QEBD730 Weatherstrip

(Exposed Barb Kerf In Weatherstrip with .730" Reach)



QEBD825 Weatherstrip

(Exposed Barb Kerf In Weatherstrip with .825" Reach)

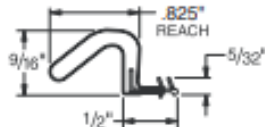

QEBD928 Weatherstrip

(Exposed Barb Kerf In Weatherstrip with .928" Reach)

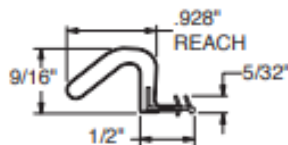

Window and Door Components
4504 10 Street NE
Calgary AB T2E 6K3
www.wndc.com



PATIO DOOR COMPONENTS

PATIO DOOR COMPONENTS

PATIO DOOR HANDLE SETS

1. Standard colours: White
2. Other colors/finishes available by request.

1. Active w/ Single Point Lock/Keeper
2. Active w/ Multi Point Lock/Keeper
3. Dummy (no lock system)

All handle sets come kitted with the following:

1. Inside Pull
2. Outside Pull
3. Screws
4. Thumb Turn (if active)
5. Lock/Keeper (if active)

**Key Cylinder option also available*

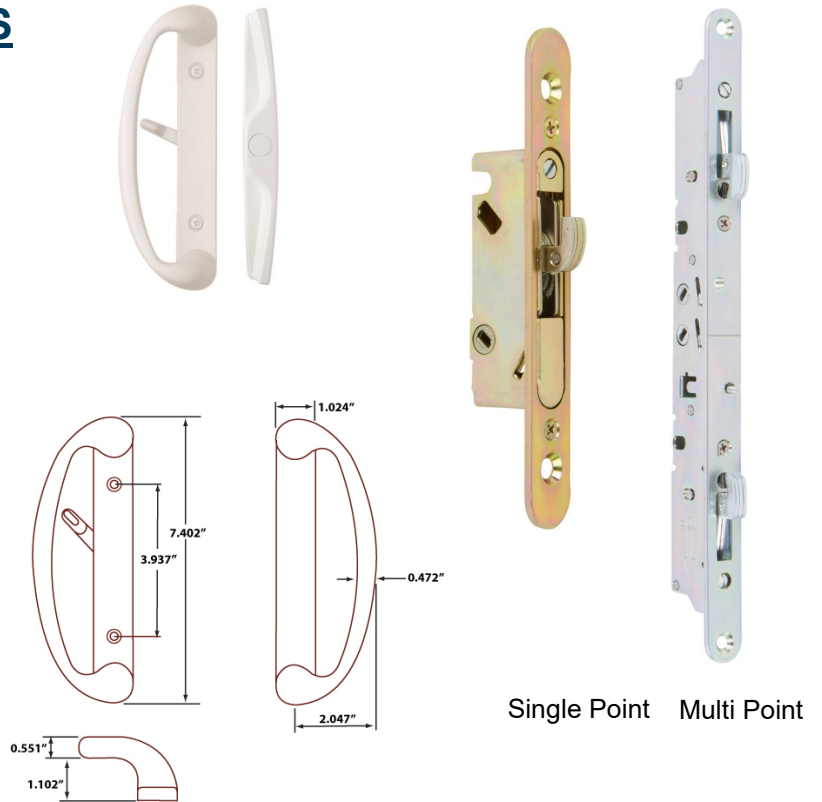
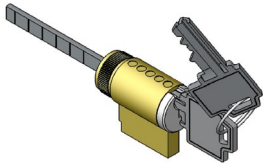

Single Point Multi Point

Rubber sliding patio door bumper - 2-5/8" long. Attaches to the jamb and is used to prevent doors from slamming.

Available Colors: Black, White

2-5/8" Door Bumper—Black

2-5/8" Door Bumper—White

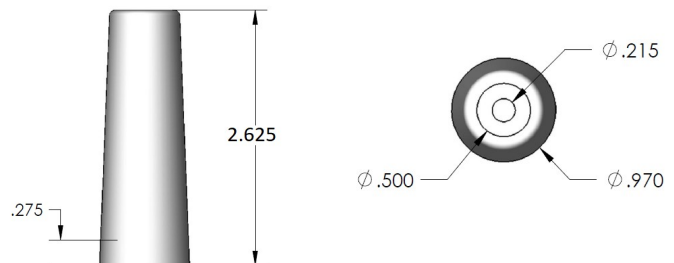

Window and Door Components
4504 10 Street NE
Calgary AB T2E 6K3
www.wndc.com

PATIO DOOR PRODUCTS

PATIO DOOR ROLLERS

1976-4000-PSS Patio Door Precision Roller-Stainless Steel

WHEEL DIA	ADJUSTMENT	
	MIN	MAX
1-1/4" O.D.	1.32	1.74
1-1/2" O.D.	1.44	1.86

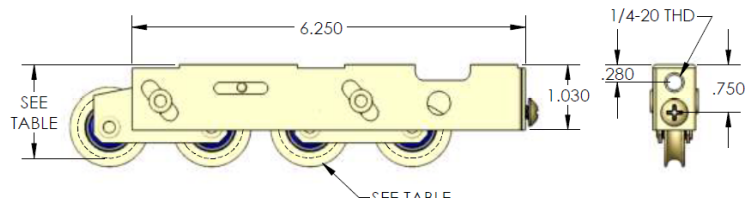
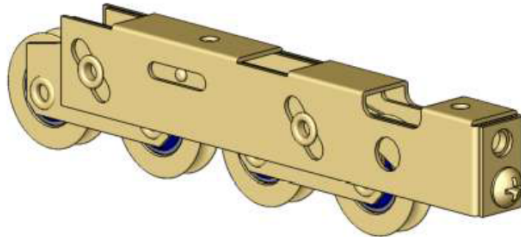

PATIO DOOR ROLLERS

Available in rolled steel or stainless steel wheels/housing combinations for smooth and long-lasting operation.

1978-4000-PSS Patio Door Precision Roller-Stainless Steel

1978-4000-PB Patio Door Precision Bearing Roller

WHEEL DIA.	C2 ADJUSTMENT		C3 ADJUSTMENT	
	MIN	MAX	MIN	MAX
1-1/4" O.D.	1.56	2.01	1.43	1.88

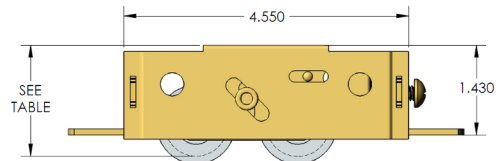
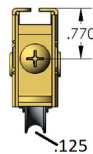
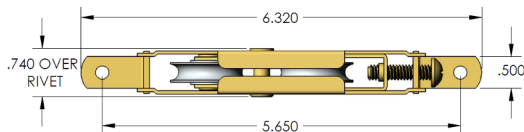

1984-PRS-125 Patio Door Precision Roller - Standard Mounting

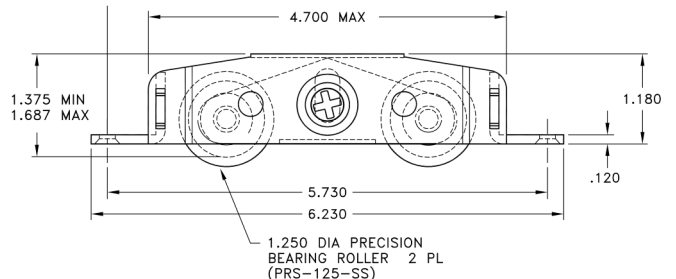

Window and Door Components
4504 10 Street NE
Calgary AB T2E 6K3
www.wndc.com